

ASSEMBLY INSTRUCTIONS

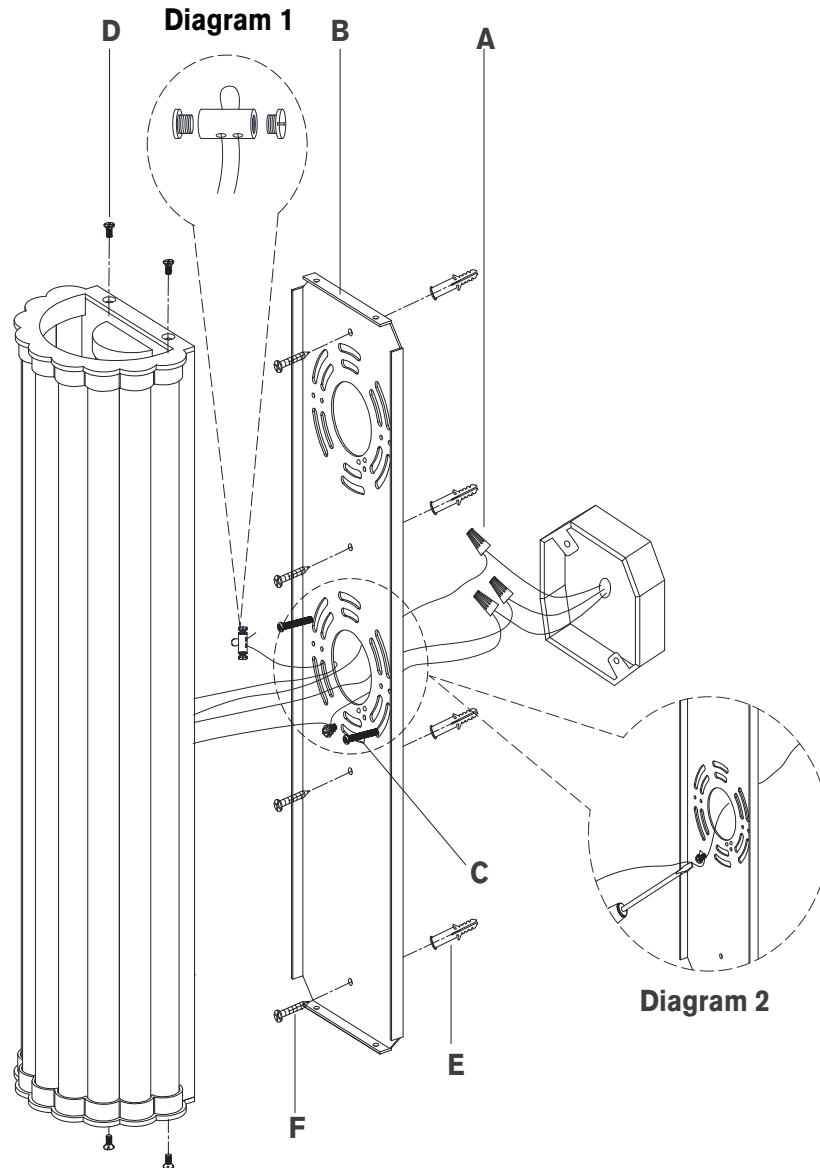

Kean 28" Sconce

Item # CHD 2927

NOTICE:

This light fixture should be installed in accordance with all applicable, local installation codes, and by a person familiar with the construction and operation of it, as well as the hazards involved. Inspect item and contents carefully. If any damage or defect is found, do not install. Retain all packaging material until installation is complete and approved.

TOOLS REQUIRED (NOT INCLUDED):

Phillips Screwdriver

Slotted Screwdriver

Drill

Pencil

Hammer

1. Carefully remove all parts from the box. Place on a clean, soft surface.
2. Remove mounting plate **(B)** from fixture by removing screws **(D)**.
3. Using the mounting plate **(B)** as a guide, line up with the junction box and mark anchor positions.
4. Using a drill bit slightly smaller than the anchor, drill holes in the marked positions. Install anchors **(E)** into the holes using hammer.
5. Install mounting plate **(B)** to the junction box and secure with mounting screws **(C)**, then secure wood screws **(F)** to anchors **(E)**.
6. Run support cable through hole on back of mounting plate **(B)**. Loosen cable lock and install to end of cable as shown in diagram 1. Tighten ends with a screwdriver to secure.
7. Wrap fixture ground wire (bare copper) around the green grounding screw. Tighten. Continue fixture ground wire and connect to supply ground wire (usually green or bare copper) using wire nut **(A)**.
8. Connect fixture neutral wire (white) to the supply neutral wire (usually white) using wire nut **(A)**.
9. Connect fixture hot wire (black) to the supply hot wire (usually black) using wire nut **(A)**.

CAUTION: Do not reverse the hot and neutral connections.

ASSEMBLY INSTRUCTIONS

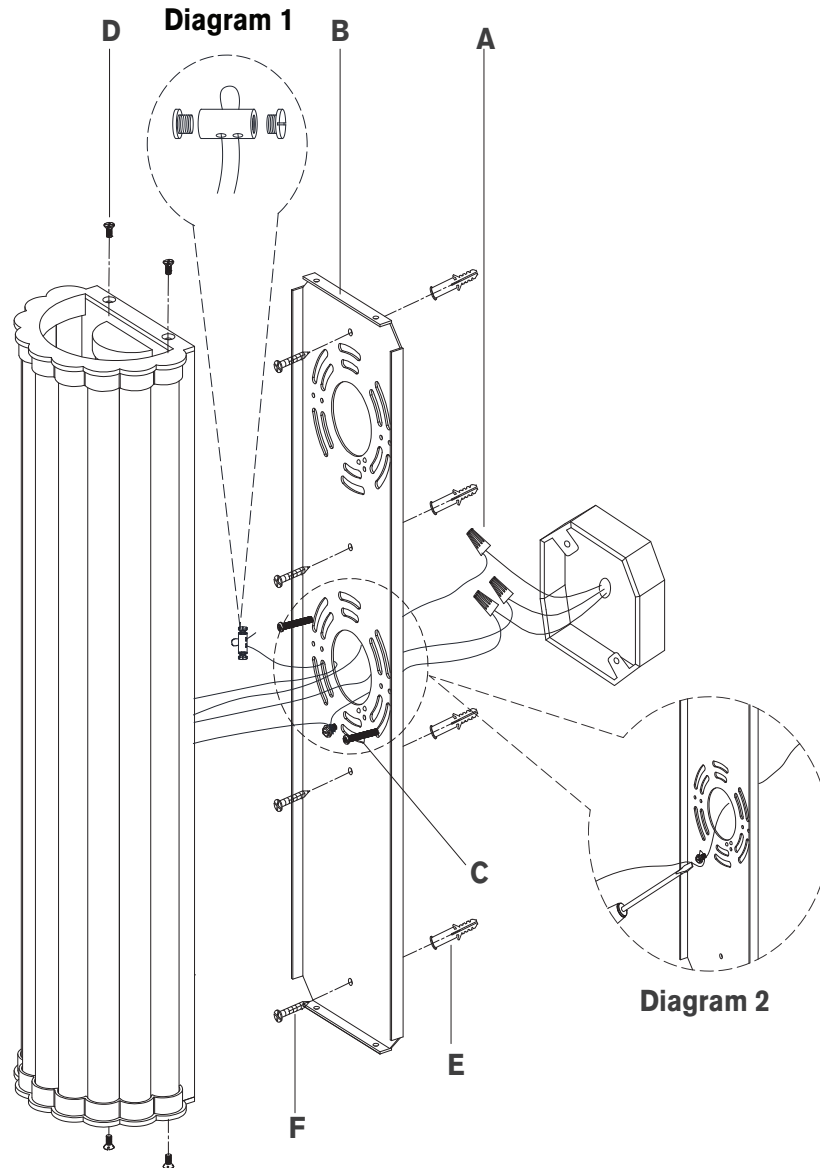

Kean 28" Sconce

Item # CHD 2927

NOTICE:

This light fixture should be installed in accordance with all applicable, local installation codes, and by a person familiar with the construction and operation of it, as well as the hazards involved. Inspect item and contents carefully. If any damage or defect is found, do not install. Retain all packaging material until installation is complete and approved.

10. Make sure all wire connections are tight, then carefully tuck into the junction box.
11. Install fixture to mounting plate **(B)** by securing with screws **(D)**.

Care Instructions: Clean only with a soft dry cloth or feather duster. Do not use abrasive or chemical agents.